

ARCTIC DISCOVERIES

Yukon



Maatschetsen

Yukon

AD\_BN\_WTB

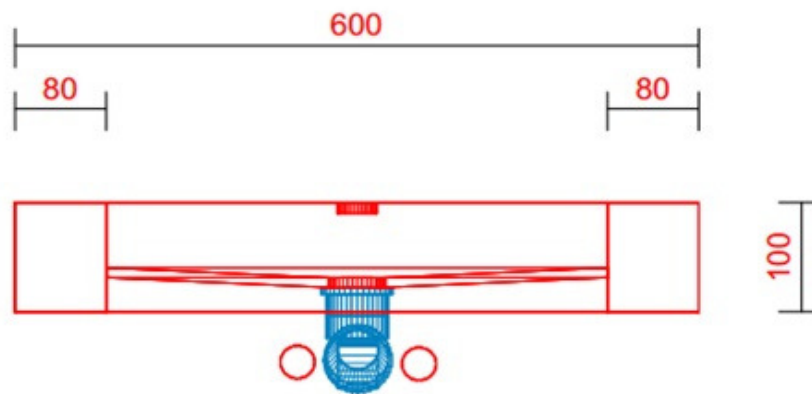
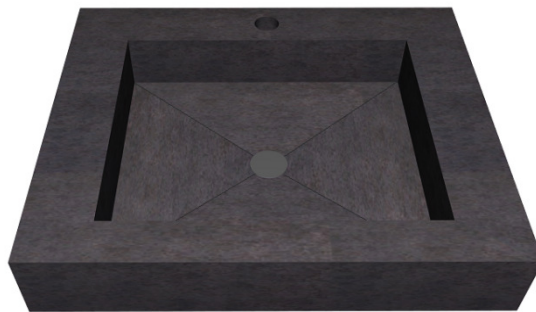

VOOR-AANZICHT

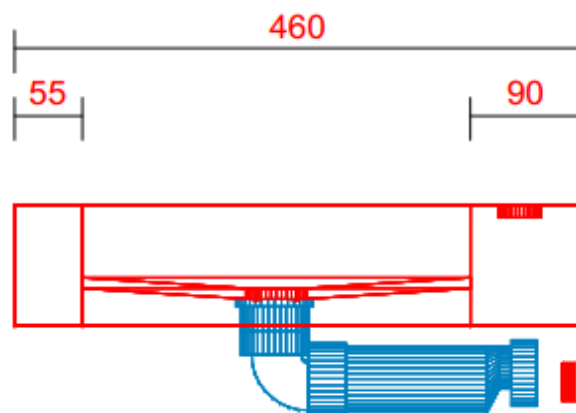

ZIJ-AANZICHT

AD\_YN\_WM

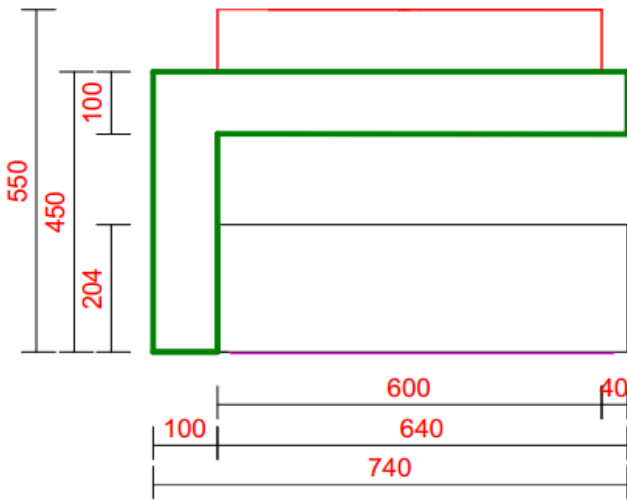

WASTAFEL VOOR-AANZICHT  
UITVOERING: RECHTS

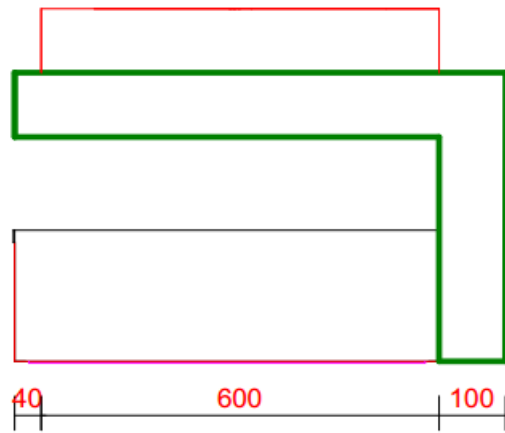

WASTAFEL VOOR-AANZICHT  
UITVOERING: LINKS

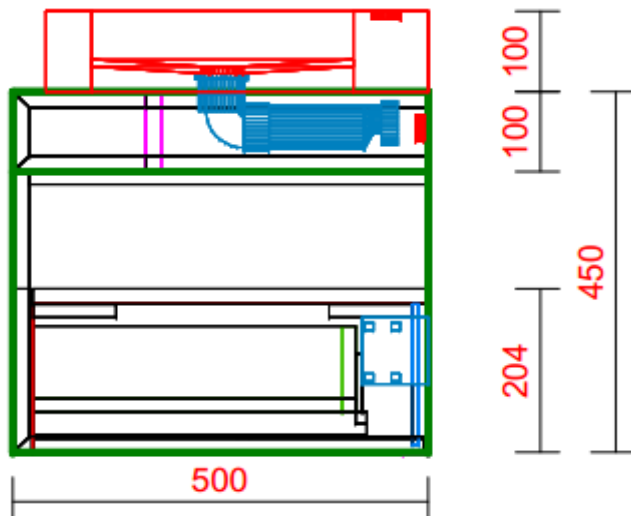

ZIJ-AANZICHT WASTAFEL

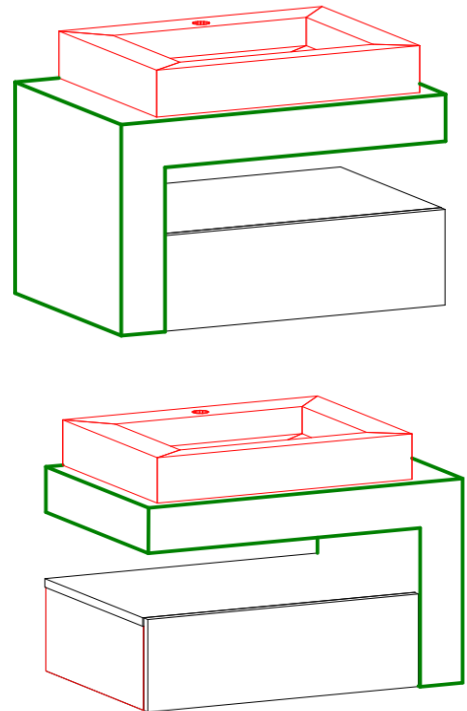

## AD\_YK\_SP

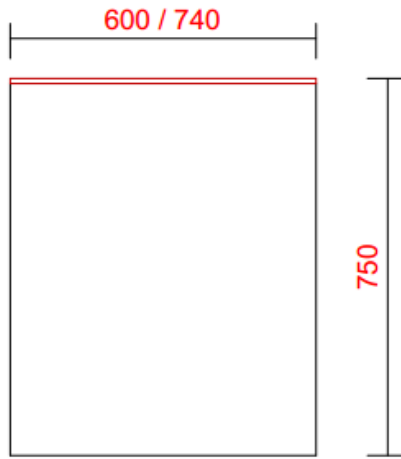

VOOR-AANZICHT SPIEGEL

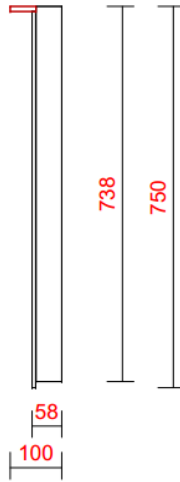

ZIJ-AANZICHT SPIEGEL

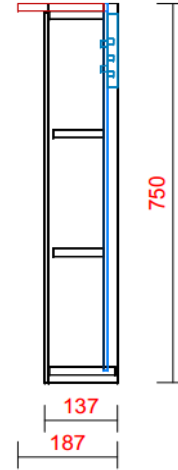

ZIJ-AANZICHT SPIEGELKAST

## AD\_YK\_SK60

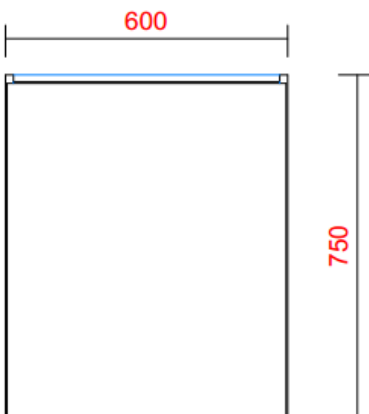

ZIJ-AANZICHT SPIEGEL

## AD\_YK\_SK74R

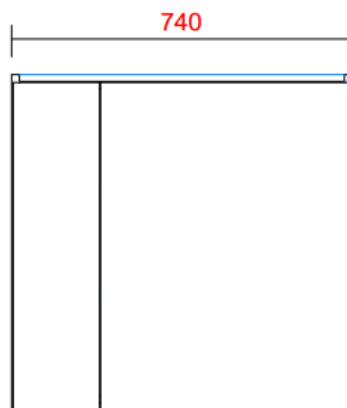

UITVOERING RECHTS  
VOOR-AANZICHT SPIEGELKAST

## AD\_YK\_SK74L

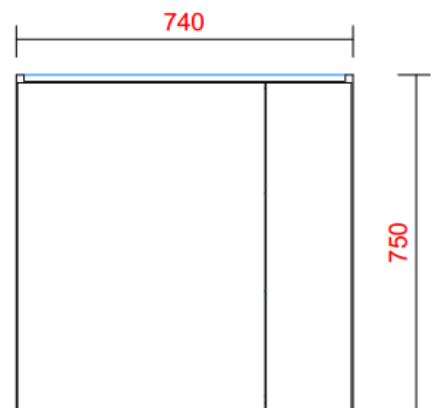

UITVOERING LINKS  
VOOR-AANZICHT SPIEGELKAST

AD\_YK\_SKR60

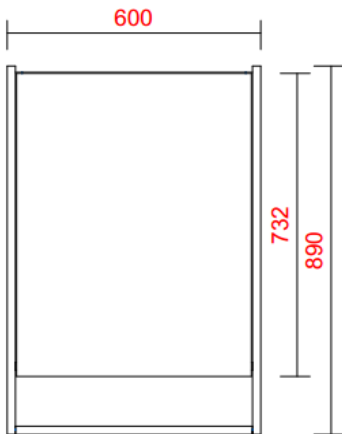

AD\_YK\_SKR74R

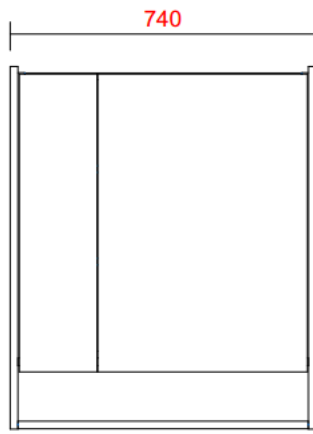

AD\_YK\_SKR74L

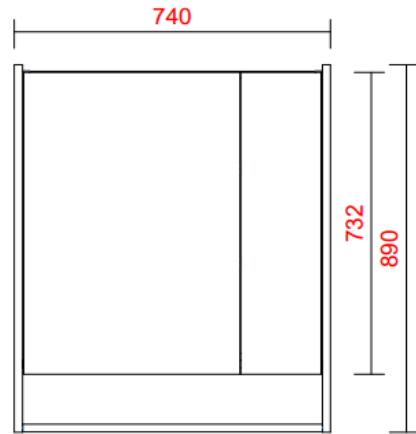

UITVOERING RECHTS

UITVOERING LINKS

VOOR-AANZICHT SPIEGELKAST MET REGAAL

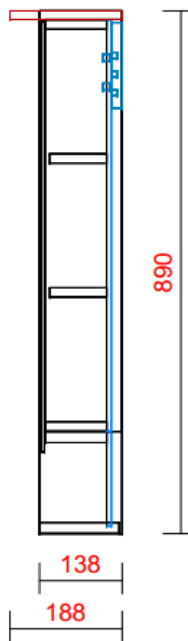

ZIJ-AANZICHT SPIEGELKAST MET REGAAL

# YUKON MAATSCHETS

Uitgaande van bladhoogte 900mm.

Wanneer men hiervan afwijkt, dient men hiermee rekening te houden en door te berekenen.

\* Afmetingen zijn gebaseerd op kastbreedte 500mm

Kast 450mm:  $452 - 50 = 402\text{mm}$

Kast 400mm:  $452 - 100 = 352\text{mm}$

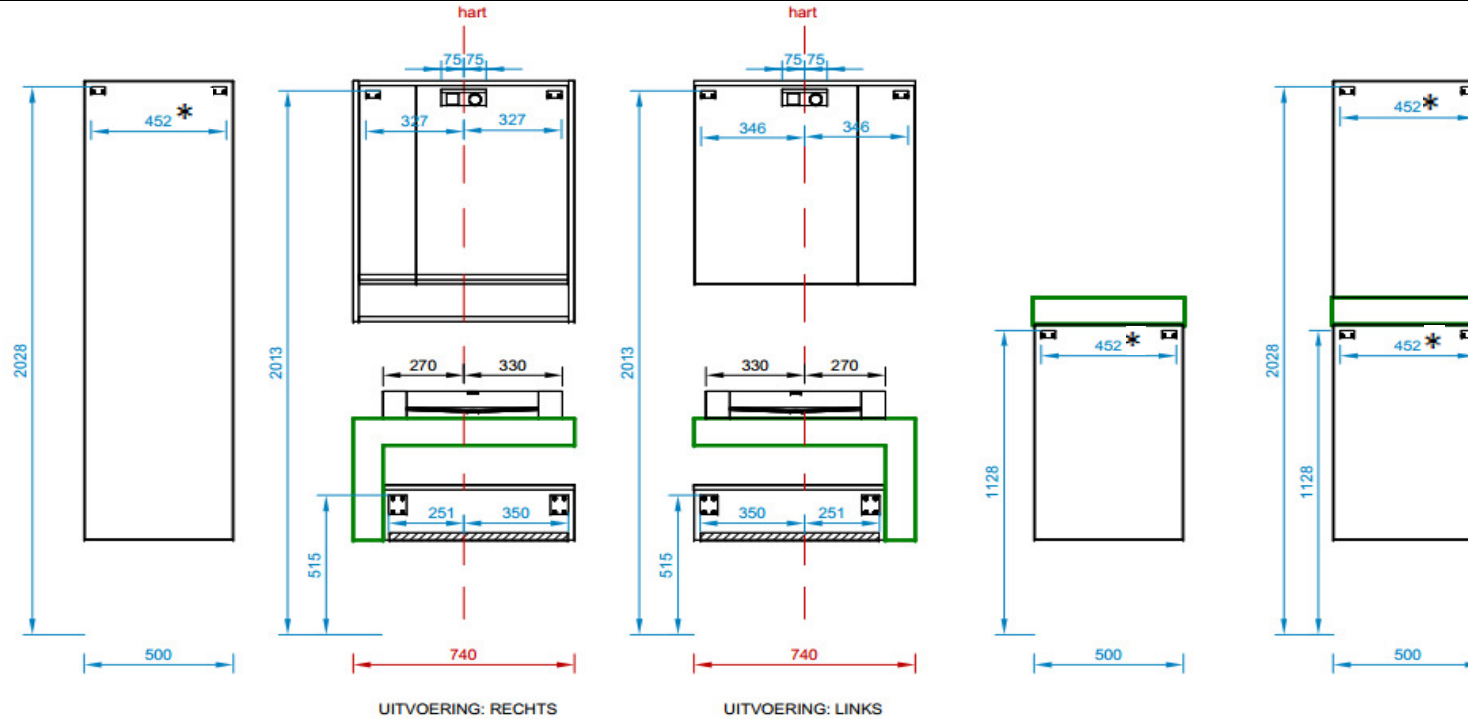

## DETAIL OPHANGLAT

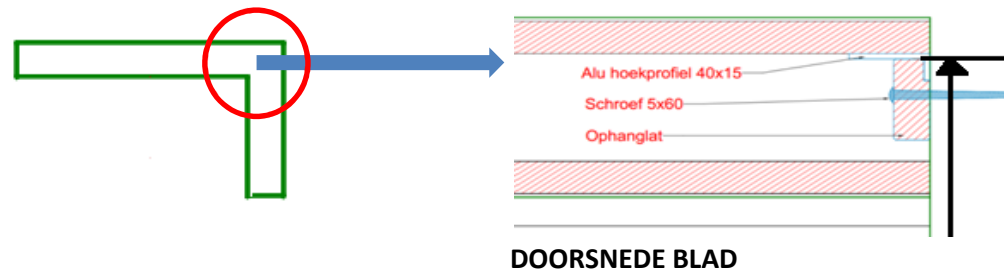

# YUKON water- en electra voorschriften

